

Publish Date : 15.12.2019 | Rev no: 01

3 Port US Style Designer CurvaPlate

The DINTEK CurvaPlate™ Designer wallplates are designed for use with DINTEK's keystone style jacks and modules. The CurvaPlates contemporary design is ideal for use in today's office, hotel, home office, or residential environment. The clip on front faceplate allows for the termination of the outlet before painting/decorating of walls are finished and the faceplates can be clipped on at the finish, allowing for a perfect finish that covers any fixing screws.

Features

- Comes in single and dual options
- Fits all DINTEK keystone style modules
- Front plate clipped on for quality finish, covering screw fixings
- Stylish contemporary design

Material

- Wallplate: PC,UL94V-0

Physical Characteristics

- Operating Temperature Range:-10°C to 60°C
- Storage Temperature Range:-40°C to 68°C
- Humidity:10%~90% RH
- Dimensions: 70 x 120 mm

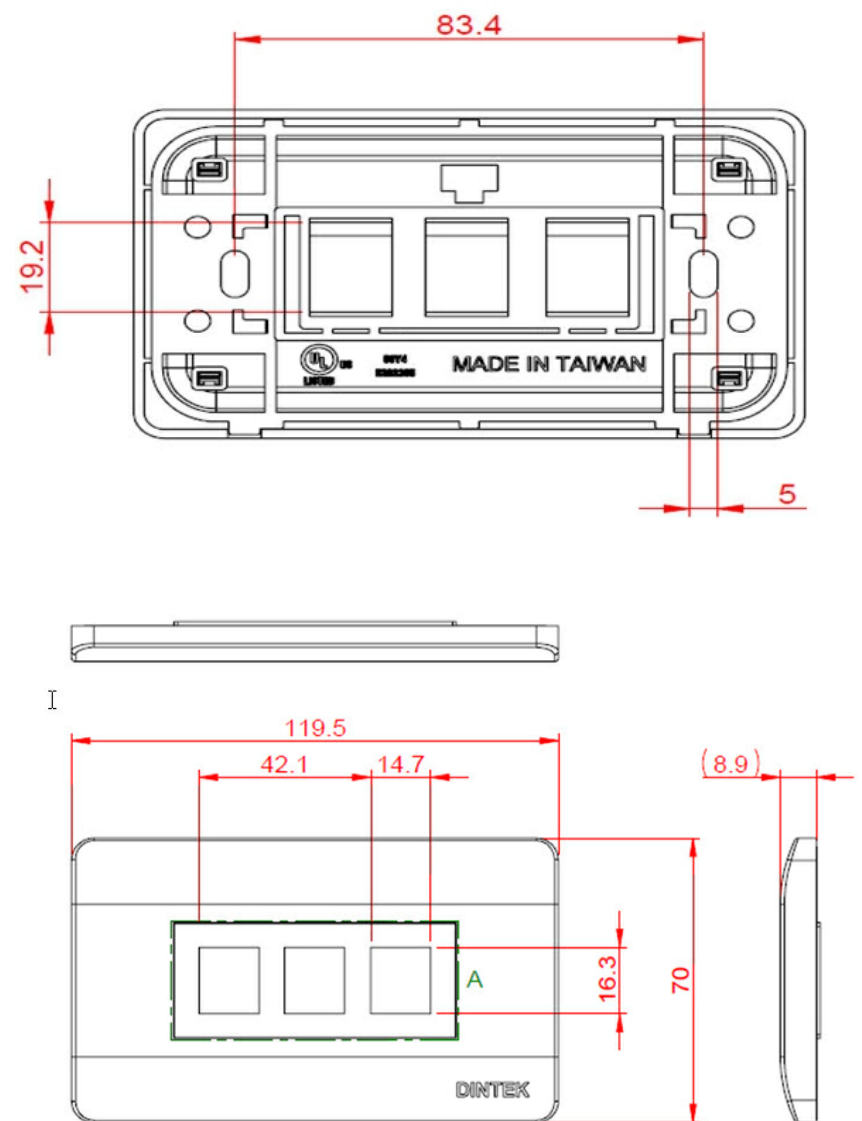
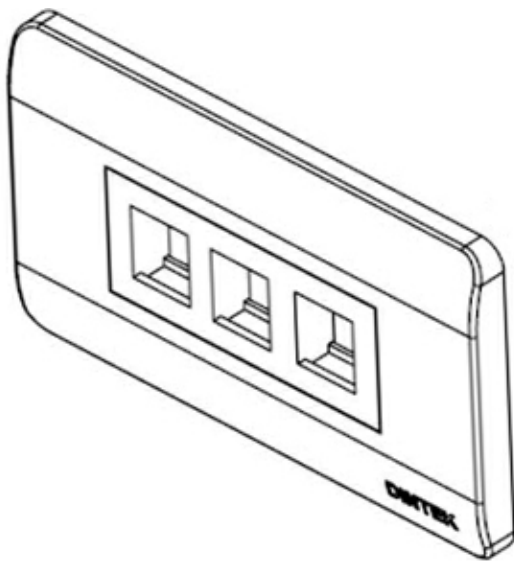

Ordering Information

Product Number	Product Name	Dimensions	Std Pkg Qty	Std Ctn Qty
1303-11039	3 Port US Style Wallplate CurvaPlate	70 x 120 mm	150	300
1303-11031	2 Port US Style Wallplate CurvaPlate	70 x 120 mm	150	300
1303-11030	1 Port US Style Wallplate CurvaPlate	70 x 120 mm	150	300